



# Films

# Films

## 03. What are films and how are they used?

Films bring sophistication to everything from packages to automobile and architectural graphics.

There are two major types of films: solvent-cast and co-extruded. In one type of highly controlled film extrusion process, plastic polymer pellets are melted and pumped through flat dies. What emerges is a thick sheet of film, stretched to enhance physical properties.

The precision of the extrusion and stretching processes gives each film material unique die-cutting and dispensing characteristics.

### Label and Packaging Materials North America conformables portfolio:

- Global MDO
- 3.0 Mil MDO
- Primax™
- FasClear™
- GCX™



Solvent cast digital print films used for architectural applications.



Global MDO



Shrink films — sleeves

## Film properties — assessing physical characteristics

A few of the key factors used to evaluate film properties are thickness, stretch, tear direction, tensile strength and appearance.

### Thickness

- Micrometer or caliper, check against standard film types

### Stretch

- Pull film between fingers, both MD and CD direction; lack of stretch indicates orientation in that direction; films are either unoriented or oriented in one or both directions

### Tear

- Notch the film and tear by hand; high ease of tear may indicate orientation in that direction

### Tensile strength

- Yield tensile strength is the force to stretch a film sample to its yield point (yield point is the point beyond which the stress causes permanent deformation of the material, i.e. after load is removed the sample does not go back to its original shape).

### Tensile strength (continued)

- Ultimate tensile strength is the force to break a sample

### Appearance

- A few ways to judge a film's looks are observing if its glossy or dull, hazy or transparent, white or clear? Sides same or different?

## Examples of where films are used in our business units and market segments:

### Label and Packaging Materials

Beer & Beverages



Rigid PP Films

Household & Personal Care



Conformable PE-PP Films

Durables Compliance Labels



White PET Films

### Retail Branding and Information Solutions

Retail Bags for Apparel or Home



LLDPE or PP Films

### Medical Solutions

Medical Market Ostomy Bag



PVDC Film

Medical Market Surgical Incise Drape

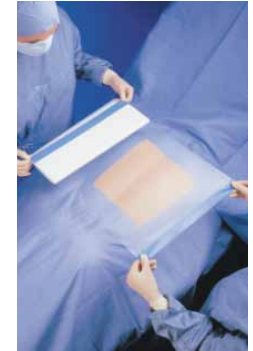

Polyurethane Film

### Graphics and Reflective Solutions

Cast Digital Overlaminate Film Vehicle Graphics



PVC Film

### Performance Tapes

Industrial Double-Coated Tape

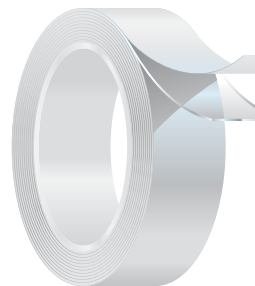

PET Carrier Film

### Office and Consumer Products

Consumer Office Products Binders



PP or PVC Films

Consumer Office Products Sheet Protector



PP Films

### Security and Converting Division

Architecture Fluoropolymer cast printed film

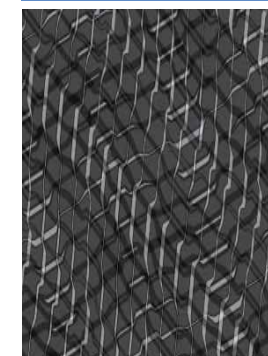

Coating for PVC siding

### Designed and Engineered Solutions

Food, Microwave Steaming



Polyurethane Film

# Films

## Co-extruded films

These films are multi-layer films, which can be engineered for specific usages. Properties like printability, moisture resistance, opacity, and conformability are some of the benefits co-extruded films offer for packaging, architectural and industrial applications.

### Co-extruded films benefits:

- Cost-effective printing on transparent and opaque films
- Films have more resistance to punctures and tearing
- Great barrier properties
- High seal integrity for longer shelf life
- Cost-effective adhesion to coatings

## Film layer definitions

- **print layer:** *the printable surface of the film*
- **tie layer:** *binds multiple layers together*
- **core layers:** *primary layer (examples are opaque layers, stiffening layers, etc.)*
- **adhesive layer:** *the adhesive layer binds the film to the object or surface*
- **barrier layer\*:** *prevents gaseous diffusion*

\* not shown in diagram to the right

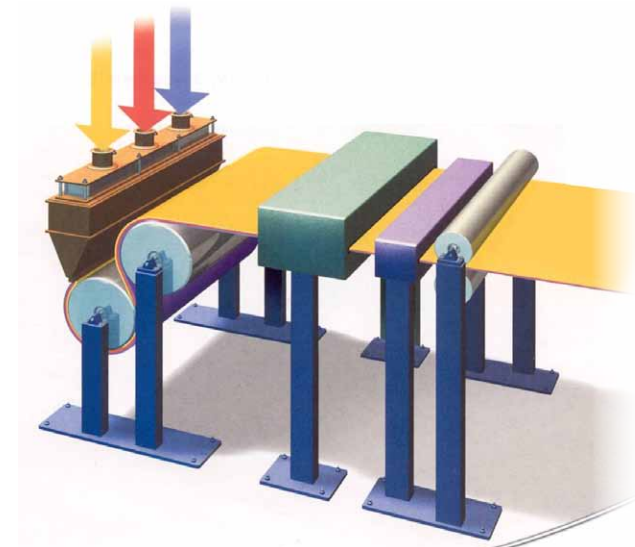

Film manufacturing process - each arrow in the diagram represents a different layer of film

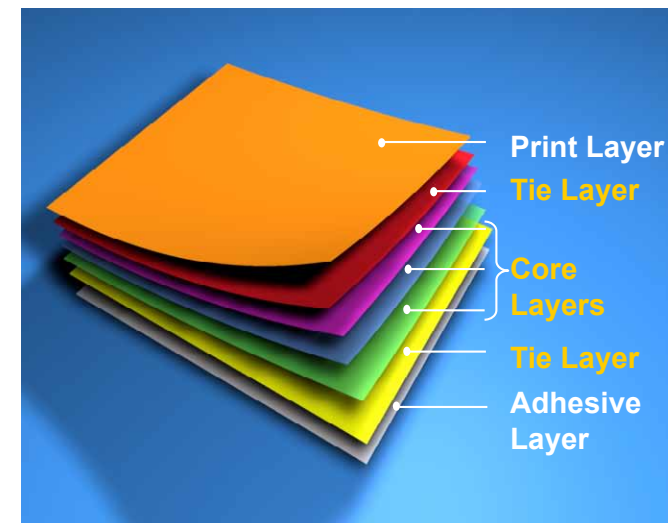

Diagram of a film's component layers

# Films

## How co-extruded films are made.

Plastic polymer pellets are loaded into an extruder which heats, compresses and melts the polymer into the desired caliper (gauge). Multiple layers of polymers can be created and merged simultaneously into a multilayer film.

These layers have different functions, from the print layer, to the opacifying layer, and the adhesive promoting layers. The extruded films can optionally be machine directed oriented (MDO).

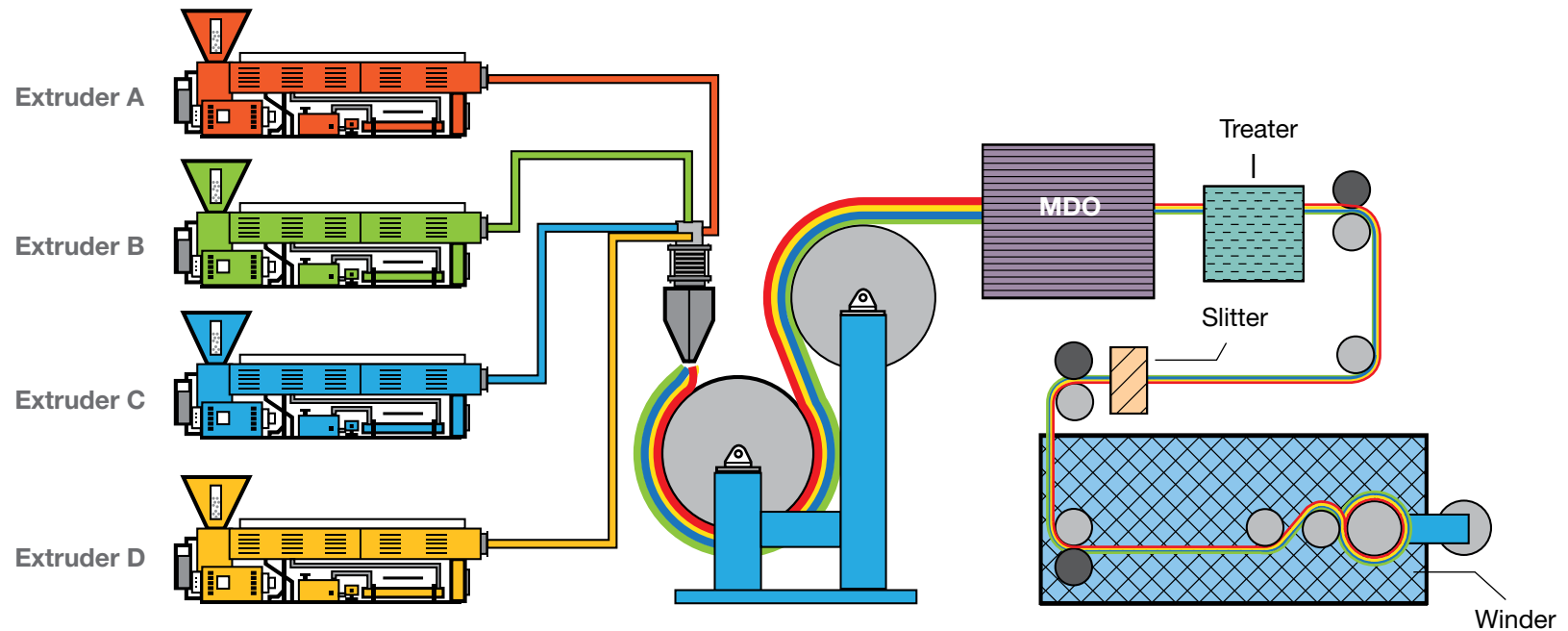

Avery Cast Co-Extruded MDO Process

## Other film applications

Two different ways co-extruded films can be utilized are with in-mold films and shrink films.

### In-mold films

During the container's manufacturing process, a label is placed into an open mold. When plastic resin is extruded into the mold, it conforms to the shape of the object. The end result? A beautiful, squeezable container that does not require additional labeling steps or equipment, and has a "no-label" appearance. Our value to the customer:

- squeezable label
- "no-label" look
- conformable to complex shapes

### Shrink films

Roll-fed shrink films are one of the fastest-growing label decorating technologies, providing the benefit of shrink sleeves at a lower cost. The film we distribute has a shrink ratio from 15% up to 50%, that can be applied to traditional roll-fed labeling using hot-melt or UV glue, and advanced technologies such as laser and ultrasonic welding. Shrink films conform to the shape of the object and allow more of the curved surfaces to be used for graphics and information. Our value to the customer:

- one-step shrink labeling
- innovative roll-fed shrink label
- effective & economical



Clear films



Conformable, "squeezable" films

# Films

## Other types of films

The majority of films Avery Dennison uses are sourced externally (e.g. adhesives, lamination, etc.); but are combined with other unique internal capabilities. The primary types of films used are:

- cast film
- MDO optional film
- blown film
- bi-axially oriented film

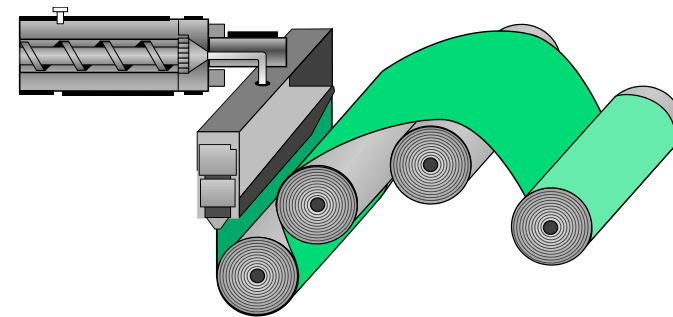

CAST FILM PROCESS

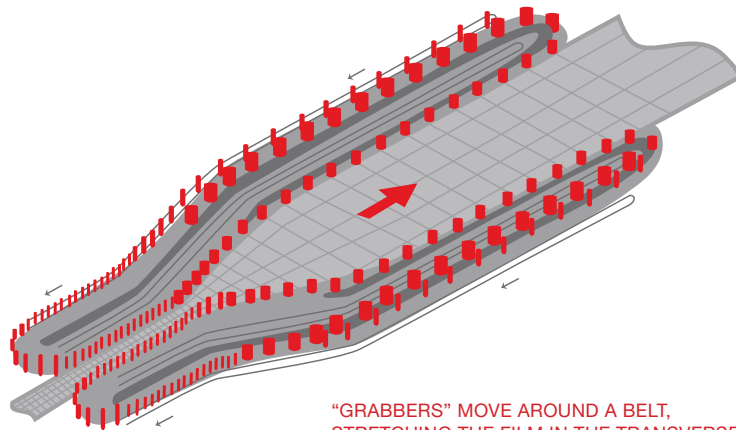

"GRABBERS" MOVE AROUND A BELT, STRETCHING THE FILM IN THE TRANSVERSE DIRECTION AFTER FILM LEAVES MDO

BI-AXIALLY ORIENTED FILM

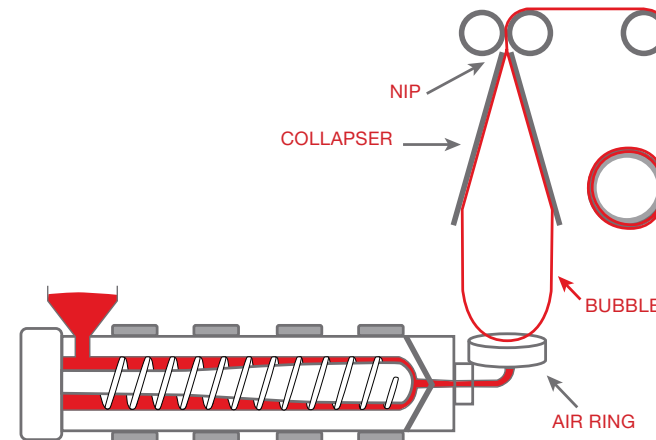

BLOWN FILM PROCESS



## Our value to the customer

We offer solutions that both enhance and amplify the product message, and provides essential elements which differentiate them from the competition.

In industries like food packaging and pharmaceuticals, films provide not only high quality printable surfaces for graphics, but also offer protection, durability and security (tamper-proof) for products.

In areas like architecture, films can provide surfaces for high-impact graphics, protection from graffiti, as well as environmental benefits of temperature control, solar energy photovoltaic surfaces, and other uses.

- High-quality printable surfaces
- Durability
- Protection
- Enhanced functionality
- Customized film solutions

## A variety of benefits

Avery Dennison co-extruded films are engineered to fill a variety of needs depending on usage requirements. A few examples of our solutions are:

- Films designed to withstand various manufacturing processes, including bottling, washing, hot-filling, pasteurization and retort
- Films able to accept heavy-screened inks as well as more typical printing and converting technologies
- Films which adhere to a diverse range of container materials including glass, PET and HDPE
- Overlaminated films that provide increased protection for products from scratches, graffiti, and sunlight, protecting indoor and outdoor surfaces from permanent damage

# Films



## Our competitive advantage

Our internal staff has in-depth knowledge of film technology and product development, and our manufacturing expertise with cast and co-extruded film with machine directed oriented is strong. We also have significant manufacturing assets in horizontal cast and multilayer extrusion.

## Other strategic capabilities:

We have film product management and purchasing divisional experts integrating sourced films into products globally.

## Film development capabilities:

- Co-extruded & oriented multilayer film design
- Resin selection & development through blending
- Pilot-scale customer prototyping and film testing

## Film manufacturing capabilities:

- Horizontal cast & MDO multilayer extrusion
- Roll conformance, winding and defect control
- Incubator for new cast & MDO film technologies